



## Entrance mats

Aluminium doormats  
Cleaning zones





**entrada**  
Fußmatten

Imprint

entrada Fußmatten GmbH  
Hinter dem Turme 5  
38114 Braunschweig

Phone: +49 (0)531 - 886 871 - 0  
Fax: +49 (0)531 - 886 871 - 11  
E-Mail: [info@entrada-matten.de](mailto:info@entrada-matten.de)  
[www.entrada-matten.de](http://www.entrada-matten.de)

Managing Director: Stefan Heuer

Version Catalogue No. 11-2024  
Valid from 4 / 2024

Our GTCs apply, see [www.entrada-matten.de/kontakt/agb/](http://www.entrada-matten.de/kontakt/agb/)

We reserve the right to make technical changes and deviations.

All prices are to be understood net, plus legal VAT.

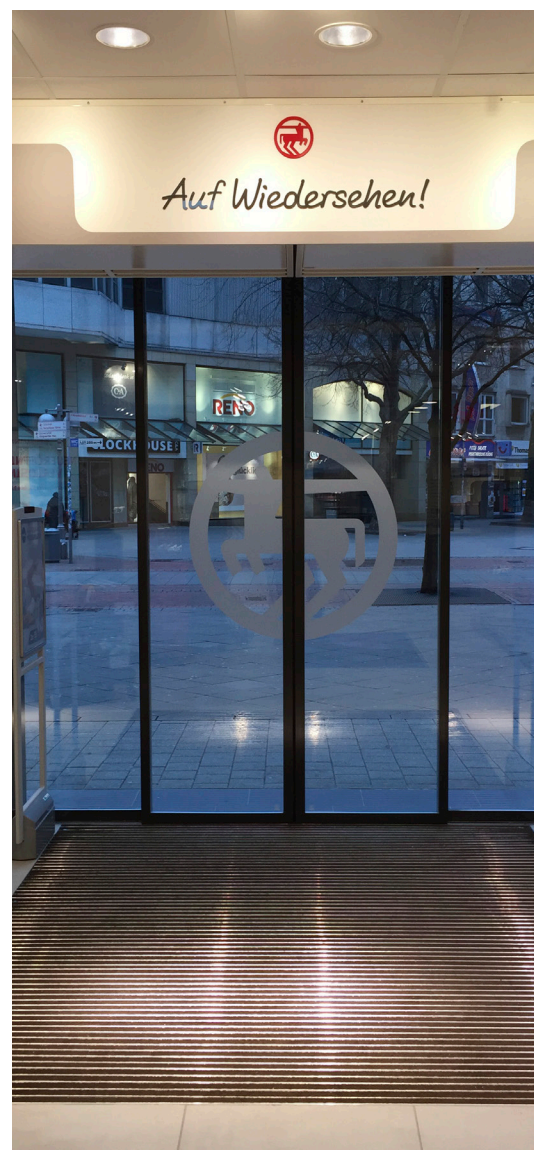



# entrada entrance mats structured into zones:

## ZONE 1 Coarse dirt and outdoor

- 12 entrada KLASSIK »Safe«
- 13 entrada KLASSIK »Work«
- 14 entrada KLASSIK »Brush«
- 15 entrada KLASSIK »Scraper«
- 19 entrada KLASSIK »Safe« / »Work«
- 20 entrada KLASSIK »Safe« / »Minibrush«
- 21 entrada WORK »Plus«
- 23 entrada ROBUST »Safe«
- 23 entrada ROBUST »Work«
- 25 entrada ROYAL »Safe«
- 25 entrada ROYAL »Work«
- 27 entrada ROYAL PLUS »Safe«
- 27 entrada ROYAL PLUS »Work«
- 29 Tactile guidance system
- 30 entrada T-REX mat module
- 31 KLASSIK "Drive" forklift mat
- 40 Rubber ring mat »Bee 22«

## Accessories and Service

- 32 Angular frame
- 33 entrada dirt trapping tray Type »22«
- 34 Ramp profile
- 34 Covering rail »Curve«
- 35 Stainless steel profile
- 35 Anodization
- 35 Levelling mat »Balance«
- 41 Correct planning for frames and mats
- 42 Ordering / custom made
- 43 Fax form

## ZONE 2 Fine dirt in indoor and covered outdoor areas

- 8 entrada SMART »Rips«
- 9 entrada KLASSIK »Rips«
- 10 entrada KLASSIK »ColourPlus«
- 11 entrada KLASSIK »Outside«
- 16 entrada KLASSIK »Rips« / »Work«
- 17 entrada KLASSIK »Rips« / »Minibrush«
- 18 entrada KLASSIK »Rips« / »Scraper Bar«
- 21 entrada WORK »Plus«
- 23 entrada ROBUST »Rips«
- 23 entrada ROBUST »Rips« / »Work«
- 25 entrada ROYAL »Rips«
- 25 entrada ROYAL »Rips« / »Work«
- 27 entrada ROYAL PLUS »Rips«
- 27 entrada ROYAL PLUS »Rips« / »Work«
- 28 Entrance mat with logo
- 29 Tactile guidance system
- 36 Ribbed raw hair mat »Easy«
- 37 Coir Mat

## ZONE 3 Fine dirt and humidity absorption zone

- 37 Coir Mat
- 38 Dirt trap mat »Klassik«
- 39 Anti-dirt mat »Maximus«

## Zones in detail

### Zone 1 Coarse dirt zone

Zone 1 is where coarse dirt is removed with the aid of rubber or brush profiles. These profile inserts are extremely weather-resistant and highly durable making them suitable for use in exposed outdoor areas.

### Zone 2 Fine dirt zone

In Zone 2, fine dirt is removed by ribbed inserts. They are suitable for use indoors as well as in covered outdoor areas. They are particularly effective in combination with rubber or brush profiles.

### Zone 3 Humidity and absorption zone

Zone 3 is located in the interior of a building. Anti-dirt mats absorb moisture and residual dirt and prevent run marks on the floor in entrance areas.

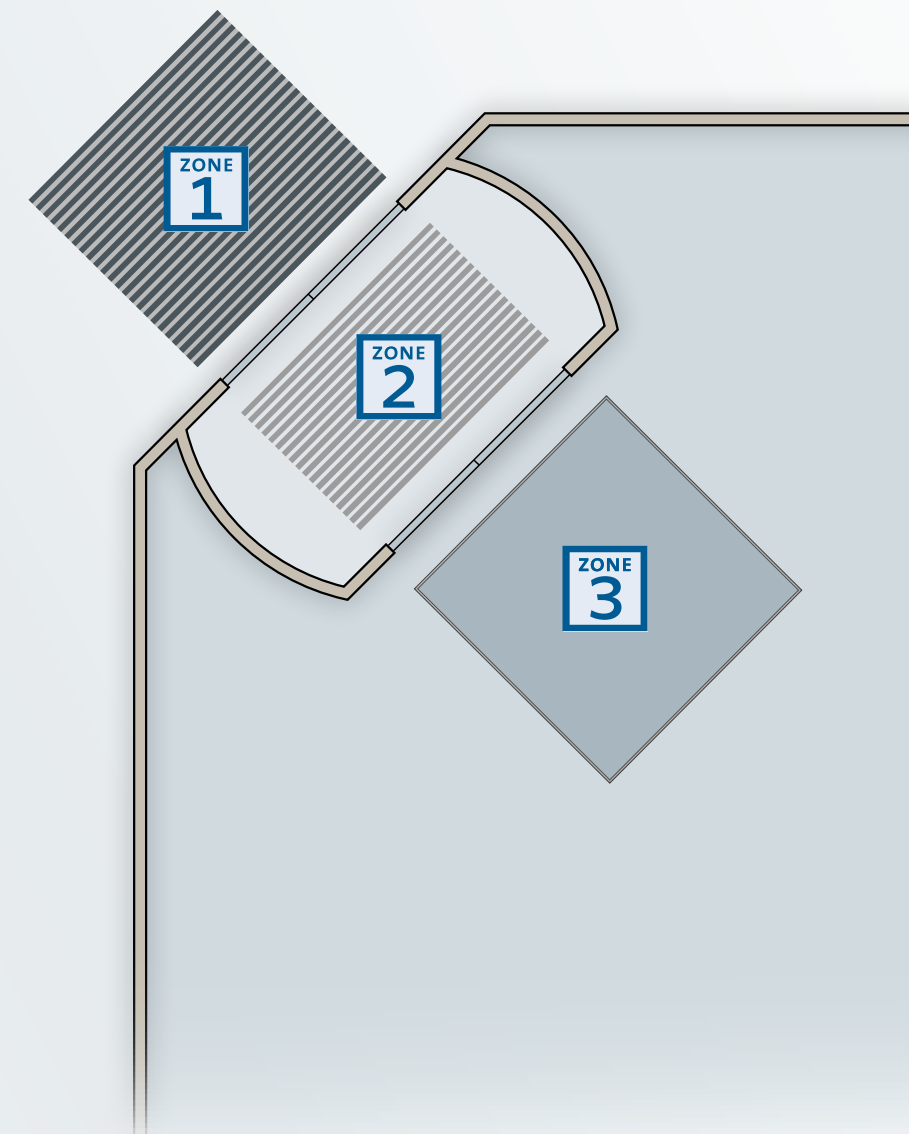

## Symbols

-  Use indoors and in roofed outdoor areas
-  Use outdoors
-  Suitable for the disabled
-  Can be driven over in a pallet truck
-  Low flammability



# Colours and variants

Combine the benefits according to requirements

## Colours

### Rips



### Smart Rips



### ColourPlus (B1 Floor)



### Rubber profile

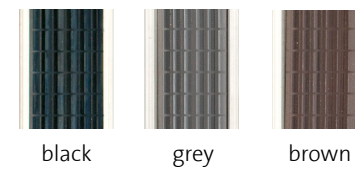

### Brush profile



### Work 4 row

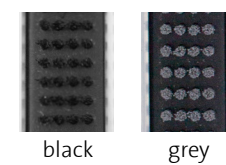

### Scraper

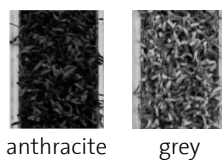

### Outside

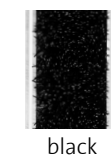

### Brush

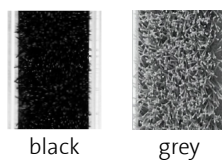

### Minibrush

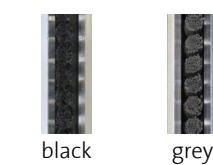

Other colours can be realised. Simply ask us!

## Combine the benefits according to requirements

entrada® entrance mats are available in a range of thicknesses and heights. The following criteria should be taken into account when choosing an entrance mat:

- The greater the thickness and installation height of the aluminium profiles, the higher the load capacity of the mat.
- The greater the mat's installation height, the bigger its dirt absorption capacity.
- The choice of upper material is determined by the location where the mat will be used and the degree of soiling.
- Additional profiles can be employed to further enhance cleaning performance.

The most common combinations are presented on the following pages. Please enquire for information about other combinations.

## Installation heights

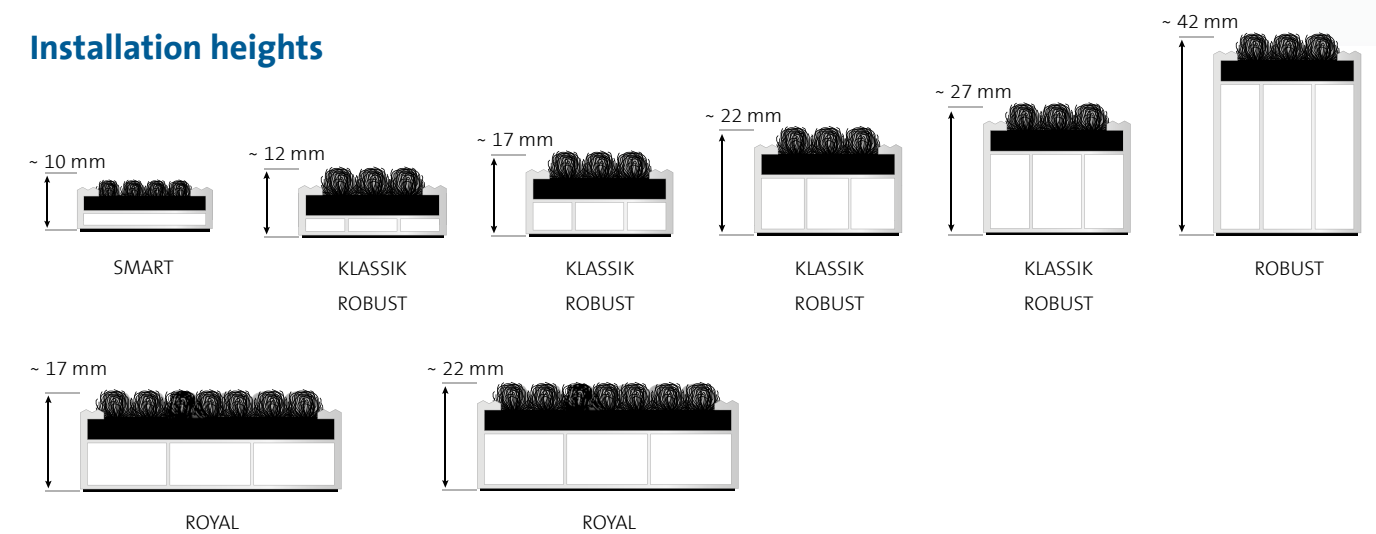

## Wall thicknesses

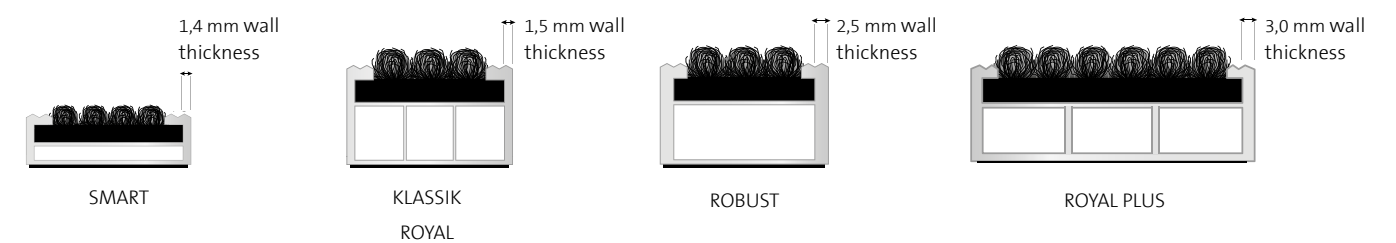

## Upper materials

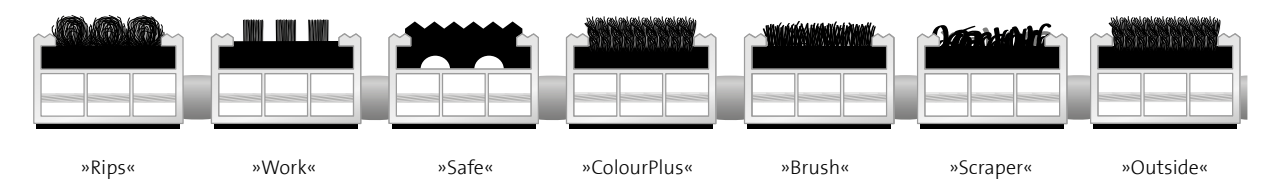

## Additional profiles

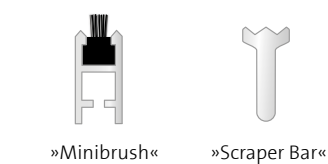





## entrada® SMART »Rips«

Aluminium profile mat with ribbing

High level of fine dirt and humidity removal in indoor and covered entrance areas with normal levels of foot traffic.



### Example applications

Entrance areas with normal levels of foot traffic, e.g. boutiques, banks, office buildings, etc.

<b>Aluminium Profile</b>	Rollable, durable entrance mat made of torsion-resistant aluminium profile ( <b>1.5 mm wall thickness</b> ) for laying directly onto the floor
<b>Upper material<sup>1</sup></b>	Polypropylene, UV-resistant, non-slip properties R11 acc. to DIN 51130
<b>Underside</b>	Footfall sound absorption profiles
<b>Connection</b>	Stainless steel cable, spacers made from LD-PE with EPDM
<b>Colours</b>	Anthracite, grey, sand
<b>Mat height (mm)</b>	10
<b>Profile distance</b>	5 mm
<b>Type of dirt</b>	Fine dirt; Zone 2

<sup>1</sup>optional with bfl-s1



These variants are also available:

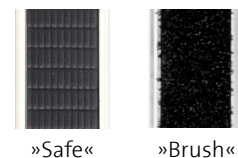

### Prices & weights (information per m<sup>2</sup>)

Height 10 mm	363,90€	~ 9,0 kg
--------------	---------	----------

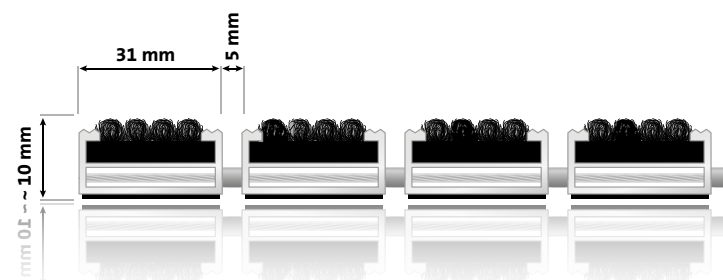

## entrada® KLASSIK »Rips«

Aluminium profile mat with ribbing

High fine dirt and humidity removal for indoor and roofed entrance areas which are frequented to a normal to heavy extent.

### Examples of use

Entrance areas which are frequented to a normal to heavy extent, e.g. boutiques, banks, office buildings etc.

<b>Aluminium profile</b>	Rollable, durable entrance mat made of torsion-resistant aluminium profile ( <b>1.5 mm wall thickness</b> ) for laying onto the ground, anodizing possible in different colours
<b>Upper material<sup>1</sup></b>	Polypropylene, UV-resistant, non-slip properties R11 acc. to DIN 51130
<b>Underside</b>	Footfall sound absorption profiles
<b>Connection</b>	Galvanised wire cable; spacers made of LD-PE with EPDM proportion
<b>Colours</b>	Black, anthracite, grey, brown, red, sand
<b>Mat height (mm)</b>	12 / 17 / 22 / 27
<b>Profile distance</b>	5 mm
<b>Type of dirt</b>	Fine dirt; Zone 2

<sup>1</sup>optional with bfl-s1



Other colours can be realised. Simply ask us!

### Prices & weights (information per m<sup>2</sup>)

Height 12 mm	373,90€	~ 10,0 kg
Height 17 mm	383,90€	~ 10,5 kg
Height 22 mm	393,90€	~ 11,5 kg
Height 27 mm	443,90€	~ 12,5 kg

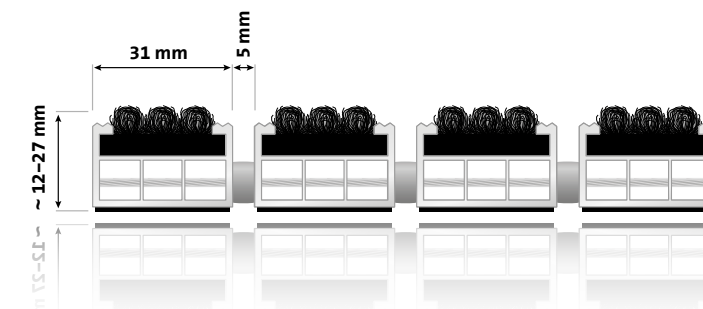





## entrada® KLASSIK »ColourPlus«

Aluminium profile mat with textile insert in B1 quality

Low flammability design for high fine dirt and humidity removal in indoor and roofed entrance areas which are normally to heavily frequented.

### Examples of use

Entrance areas which are frequented to a normal to heavy extent, e.g. boutiques, banks, office buildings etc..

<b>Aluminium profile</b>	Rollable, durable entrance mat made of torsion-resistant aluminium profile ( <b>1.5 mm wall thickness</b> ) for laying onto the ground, anodizing possible in different colours
<b>Upper material</b>	Polypropylen, UV-beständig, rutschhemmende Eigenschaft R11 nach DIN 51130
<b>Underside</b>	Footfall sound absorption profiles
<b>Connection</b>	Galvanised wire cable; spacers made of LD-PE with EPDM proportion
<b>Colours</b>	Black, anthracite, grey, brown
<b>Mat Height (mm)</b>	12 / 17 / 22 / 27
<b>Profile Distance</b>	5 mm
<b>Type of dirt</b>	Fine dirt; Zone 2



brown

Colours available for an extra charge:



black



anthracite



grey

For more colours please see page 39.

### Prices & weights (information per m<sup>2</sup>)

Height 12 mm	479,90€	~ 10,0 kg
Height 17 mm	489,90€	~ 10,5 kg
Height 22 mm	499,90€	~ 11,5 kg
Height 27 mm	553,90€	~ 12,5 kg

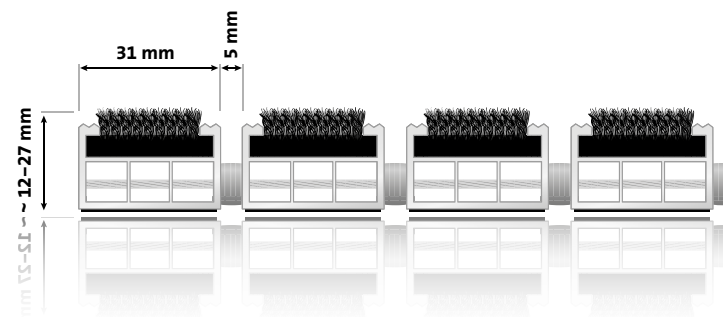

## entrada® KLASSIK »Outside«

Aluminium profile mat with textile insert

High collection of fine dirt particles and moisture, intended for inside areas and outside spaces.

### Examples of use

Entrance areas with normal to heavy foot traffic, e.g. public buildings, hospitals, schools etc.

<b>Aluminium profile</b>	Rollable, durable entrance mat made of torsion-resistant aluminium profile ( <b>1.5 mm wall thickness</b> ) for laying onto the ground, anodizing possible in different colours
<b>Upper material <sup>1</sup></b>	Recycled polyamide, PVC-free, Bfl-s1, R12 slip resistance as per DIN 51130
<b>Underside</b>	Footfall sound absorption profiles
<b>Connection</b>	Galvanised wire cable; spacers made of LD-PE with EPDM proportion
<b>Colours</b>	anthracite
<b>Mat Height (mm)</b>	12 / 17 / 22 / 27
<b>Profile Distance</b>	5 mm
<b>Type of dirt</b>	Fine dirt, Zone 1 and Zone 2



### Prices & weights (information per m<sup>2</sup>)

Height 12 mm	489,90€	~ 10,0 kg
Height 17 mm	499,90€	~ 10,5 kg
Height 22 mm	509,90€	~ 11,5 kg
Height 27 mm	549,90€	~ 12,5 kg

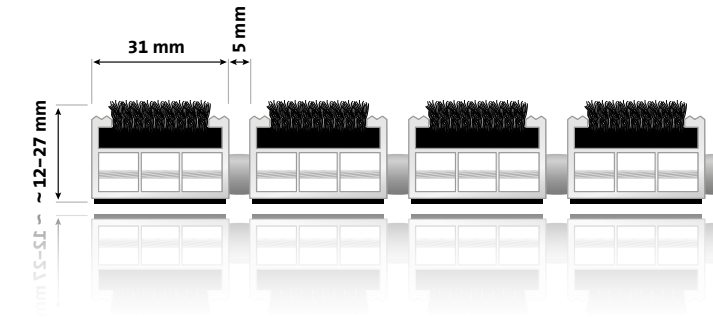





## entrada® KLASSIK »Safe«

Aluminium profile mat with rubber profile

Coarse dirt and water removal as well as increased walking safety through non-slip rubber profiles. Suitable for external areas.

### Examples of use

Entrance areas which are frequented to a normal to heavy extent, e.g. schools, shopping centres, swimming baths etc.

<b>Aluminium Profile</b>	Rollable, durable entrance mat made of torsion-resistant aluminium profile (1.5 mm wall thickness) for laying onto the ground, anodizing possible in different colours
<b>Upper material<sup>1</sup></b>	Non-slip rubber profile (EPDM), fluted, UV-resistant; non-slip properties, R9 acc. DIN 51130
<b>Underside</b>	Footfall sound absorption profiles
<b>Connection</b>	Galvanised wire cable; spacers made of LD-PE with EPDM proportion
<b>Colours</b>	Black, grey, brown
<b>Mat Height (mm)</b>	12 / 17 / 22 / 27
<b>Profile Distance</b>	5 mm
<b>Type of dirt</b>	Coarse dirt; Zone 1



<sup>1</sup>optional with bfl-s1

### Prices & weights (information per m<sup>2</sup>)

Height 12 mm	443,90€	~ 13,0 kg
Height 17 mm	453,90€	~ 14,5 kg
Height 22 mm	463,90€	~ 15,5 kg
Height 27 mm	493,90€	~ 16,5 kg

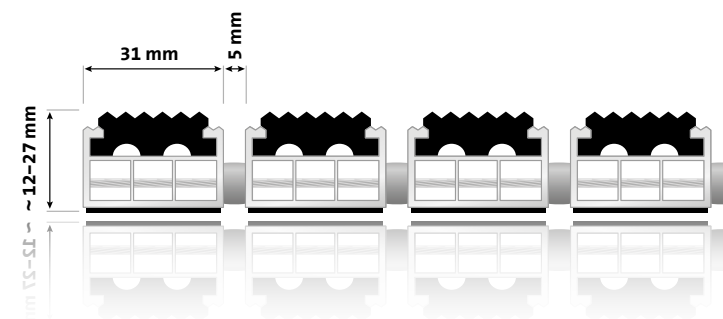

## entrada® KLASSIK »Work«

Aluminium profile mat with brush profile

Effective coarse dirt and water removal for entrances which are frequented to a normal to heavy extent. Suitable for external areas.

### Examples of use

Entrance areas which are frequented to a normal to heavy extent, e.g. schools, shopping centres, sports centres etc.

<b>Aluminium profile</b>	Rollable, durable entrance mat made of torsion-resistant aluminium profile ( <b>1.5 mm wall thickness</b> ) for laying onto the ground, anodizing possible in different colours
<b>Upper material<sup>1</sup></b>	Brush profile: robust, durable Nylon 6.6, non-slip properties R13 acc. to DIN 51130
<b>Underside</b>	Footfall sound absorption profiles
<b>Connection</b>	Galvanised wire cable; spacers made of LD-PE with EPDM proportion
<b>Colours</b>	Black, grey, brown, red, blue, black/grey Carrier material partly also available in brush colour
<b>Mat Height (mm)</b>	12 / 17 / 22 / 27
<b>Profile distance</b>	5 mm
<b>Type of dirt</b>	Coarse dirt; Zone 1

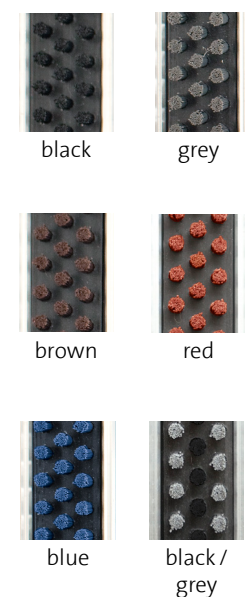

<sup>1</sup>optional with bfl-s1

### Prices & weights (information per m<sup>2</sup>)

Height 12 mm	543,90€	~ 12,0 kg
Height 17 mm	563,90€	~ 12,5 kg
Height 22 mm	583,90€	~ 13,5 kg
Height 27 mm	623,90€	~ 14,5 kg

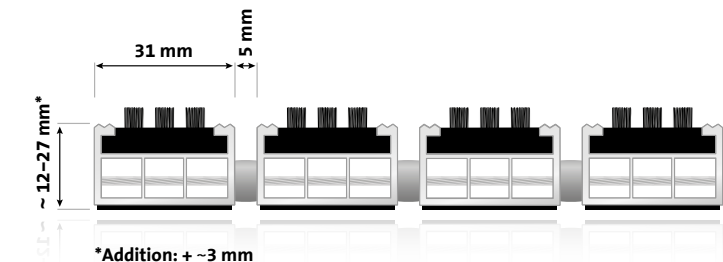

Other colours can be realised.  
Simply ask us!





## entrada® KLASSIK »Brush«

### Aluminium profile mat with brushes

Effective removal of coarse dirt and water for entrances with normal to heavy foot traffic. Suitable for external areas.

#### Examples of use

Entrance areas with normal to heavy foot traffic, e.g. schools, shopping centres, sports centres etc

<b>Aluminium profile</b>	Rollable, durable entrance mat made of torsion-resistant aluminium profile ( <b>1.5 mm wall thickness</b> ) for laying onto the ground, anodizing possible in different colours
<b>Upper material<sup>1</sup></b>	Brush profile: polyamide PA 6.6, body of brush made from polypropylene, non-slip properties R13 acc. to DIN 51130
<b>Underside</b>	Footfall sound absorption profiles
<b>Connection</b>	Galvanised wire cable; spacers made of LD-PE with EPDM proportion
<b>Colours</b>	Black, grey
<b>Mat Height (mm)</b>	12 / 17 / 22 / 27
<b>Profile distance</b>	5 mm
<b>Type of dirt</b>	Coarse dirt; Zone 1

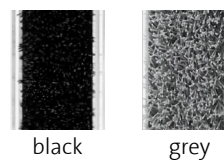

<sup>1</sup>optional with bfl-s1

#### Prices & weights (information per m<sup>2</sup>)

Height 12 mm	533,90 €	~ 11,0 kg
Height 17 mm	553,90 €	~ 11,5 kg
Height 22 mm	573,90 €	~ 12,5 kg
Height 27 mm	613,90 €	~ 13,5 kg

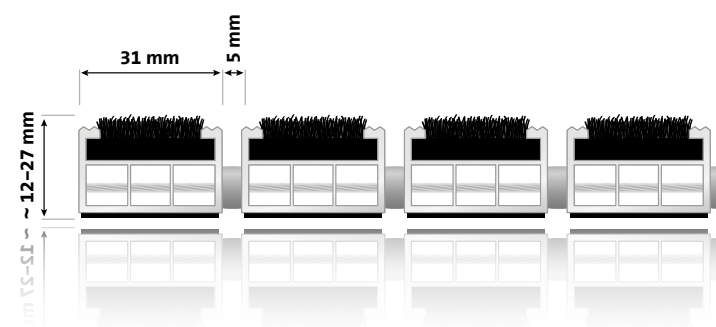

## entrada® KLASSIK »Scraper«

### Aluminium profile mat with weather-resistant inlay

Effective removal of coarse dirt and water for exterior entrances.

#### Examples of use

Entrance areas with normal to heavy foot traffic, z. B. schools, playschools, Bürogebäude etc.

<b>Aluminium profile</b>	Rollable, durable entrance mat made of torsion-resistant aluminium profile ( <b>1.5 mm wall thickness</b> ) for laying onto the ground, anodizing possible in different colours
<b>Upper material<sup>1</sup></b>	Top material <sup>1</sup> surface: 100% polypropylene, R11 slip resistance as per DIN EN 51130
<b>Underside</b>	Footfall sound absorption profiles
<b>Connection</b>	Galvanised wire cable; spacers made of LD-PE with EPDM proportion
<b>Colours</b>	anthracite, grey
<b>Mat Height (mm)</b>	12 / 17 / 22 / 27
<b>Profile distance</b>	5 mm
<b>Type of dirt</b>	Coarse and fine dirt; Zone 1, Zone 2

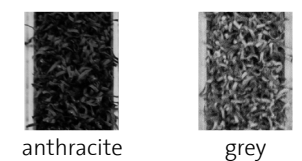

<sup>1</sup>optional with bfl-s1

#### Prices & weights (information per m<sup>2</sup>)

Height 12 mm	489,90 €	~ 12,0 kg
Height 17 mm	499,90 €	~ 12,5 kg
Height 22 mm	509,90 €	~ 13,5 kg
Height 27 mm	549,90 €	~ 14,5 kg

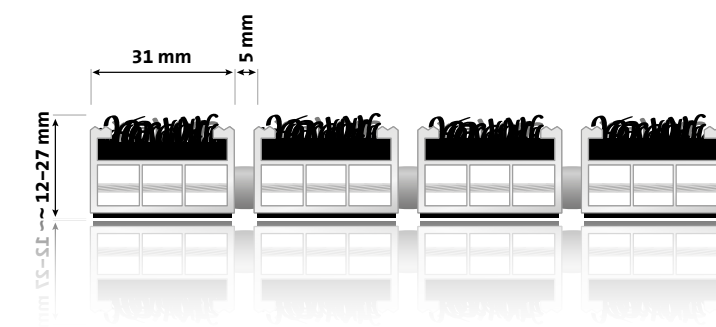





## entrada® KLASSIK »Rips« / »Work«

### Aluminium profile mat with ribbing and brush profile

Effective coarse dirt and humidity removal for entrances which are frequented to a normal to heavy extent. Suitable for indoor and roofed entrance areas.

#### Examples of use

Entrance areas which are frequented to a normal to heavy extent, for example office buildings, children's playgroups, car dealerships etc..

<b>Aluminium profile</b>	Rollable, durable entrance mat made of torsion-resistant aluminium profile ( <b>1.5 mm wall thickness</b> ) for laying onto ground, anodizing possible in different colours
<b>Upper material<sup>1</sup></b>	Ribbed: Polypropylene; UV-resistant; R11 acc. DIN 51130; brush profile: robust, durable Nylon 6.6
<b>Underside</b>	Footfall sound absorption profiles
<b>Connection</b>	Galvanised wire cable; spacers made of LD-PE with EPDM proportion
<b>Colours</b>	Ribbing: black, anthracite, grey, brown, red; Brushes: black, grey, brown, red, blue, black/grey
<b>Mat height (mm)</b>	12 / 17 / 22 / 27
<b>Profile distance</b>	5 mm
<b>Type of dirt</b>	Coarse and fine dirt; Zone 2

<sup>1</sup>optional with bfl-s1

#### Prices & weights (information per m<sup>2</sup>)

Height 12 mm	473,90€	~ 11,0 kg
Height 17 mm	483,90€	~ 11,5 kg
Height 22 mm	493,90€	~ 13,0 kg
Height 27 mm	523,90€	~ 13,5 kg

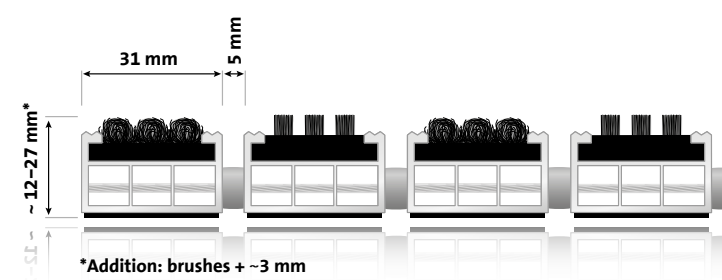

## entrada KLASSIK »Rips« / »Minibrush«

### Aluminium profile mat with ribbing and minibrush

High humidity, coarse and fine dirt removal through ribbed profiles with additional minibrushes. Suitable for indoor and roofed entrance areas which are frequented to a normal to heavy extent.

#### Examples of use

Entrance areas which are frequented to a normal to heavy extent, for example boutiques, banks, office buildings etc.

<b>Aluminium profile</b>	Rollable, durable entrance mat made of torsion-resistant aluminium profile ( <b>1.5 mm wall thickness</b> ) for laying onto the ground, anodizing possible in different colours
<b>Upper material<sup>1</sup></b>	Ribbed: Polypropylene; UV-resistant; R11 acc. DIN 51130; Minibrushes: robust, durable Nylon 6.6
<b>Underside</b>	Footfall sound absorption profiles
<b>Connection</b>	Galvanised wire cable; spacers made of LD-PE with EPDM proportion
<b>Colours</b>	Ribbing: black, anthracite, grey, brown, red; Minibrushes: grey, black
<b>Mat Height (mm)</b>	17 / 22
<b>Profile distance</b>	5 mm
<b>Type of dirt</b>	Coarse and fine dirt; Zone 2

<sup>1</sup>optional with bfl-s1

#### Price & weight (information per m<sup>2</sup>)

Height 17 mm	533,90€	~ 13,5 kg
Height 22 mm	563,90€	~ 14,0 kg

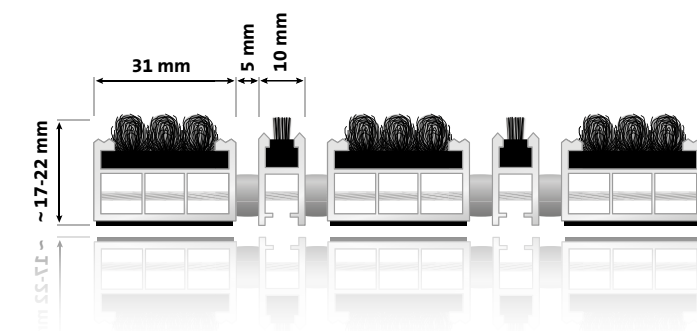





## entrada® KLASSIK »Rips« / »Scraper bar«

Aluminium profile mat with ribbing and scraper bar

High coarse and fine dirt and humidity removal through scrapers between the ribbed profiles for indoor and roofed entrance areas



### Examples of use

Entrance areas which are frequented to a normal to heavy extent, for example boutiques, banks, public institutions etc..

<b>Aluminium profile</b>	Rollable, durable entrance mat made of torsion-resistant aluminium profile ( <b>1.5 mm wall thickness</b> ) for laying onto ground, anodization possible in different colours
<b>Upper material<sup>1</sup></b>	Ribbed: Polypropylene; UV-resistant, R11 acc. DIN 51130, Scraper bar: torsion-resistant aluminium profile
<b>Underside</b>	Footfall sound absorption profiles
<b>Connection</b>	Galvanised wire cable; spacers made of LD-PE with EPDM proportion
<b>Colours</b>	Ribbing: black, anthracite, grey, brown, sand
<b>Mat height (mm)</b>	17 / 22 / 27
<b>Profile distance</b>	2 mm
<b>Type of dirt</b>	Fine dirt; Zone 2

<sup>1</sup>optional with bfl-s1

### Prices & weights (information per m<sup>2</sup>)

Height 17 mm	449,90€	~ 12,0 kg
Height 22 mm	479,90€	~ 15,0 kg
Height 27 mm	499,90€	~ 15,5 kg

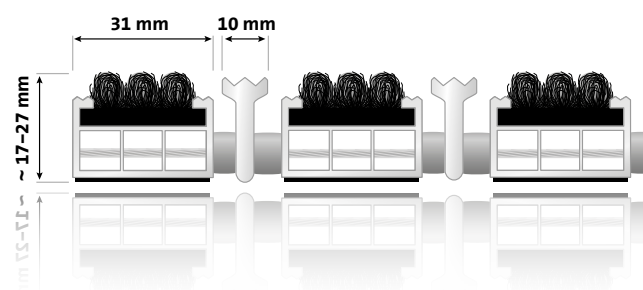

## entrada® KLASSIK »Safe« / »Work«

Aluminium profile mat with rubber and brush profile

Effective coarse dirt and water removal as well as increased walking safety through non-slip rubber profiles. Suitable for external areas.

### Examples of use

Entrance areas which are frequented to a normal to heavy extent with a high amount of coarse dirt accumulation, for example offices, children's playgroups, car dealerships etc.

<b>Aluminium profile</b>	Rollable, durable entrance mat made of torsion-resistant aluminium profile ( <b>1.5 mm wall thickness</b> ) for laying onto ground, anodization possible in different colours
<b>Upper material<sup>1</sup></b>	Non-slip rubber profile (EPDM), fluted, UV-resistant; non-slip properties R9 acc. DIN 51130; Brush profile: robust, durable Nylon 6.6
<b>Underside</b>	Footfall sound absorption profiles
<b>Connection</b>	Galvanised wire cable; spacers made of LD-PE with EPDM proportio
<b>Colours</b>	Rubber profile: black, grey, brown; Brushes: black, grey, brown, red, blue, black/grey
<b>Mat Height (mm)</b>	12 / 17 / 22 / 27
<b>Profilabstand</b>	5 mm
<b>Type of dirt</b>	Coarse dirt, Zone 1

<sup>1</sup>optional with bfl-s1

### Prices & weights (information per m<sup>2</sup>)

Height 12 mm	503,90€	~ 12,5 kg
Height 17 mm	513,90€	~ 13,5 kg
Height 22 mm	523,90€	~ 14,5 kg
Height 27 mm	553,90€	~ 15,5 kg

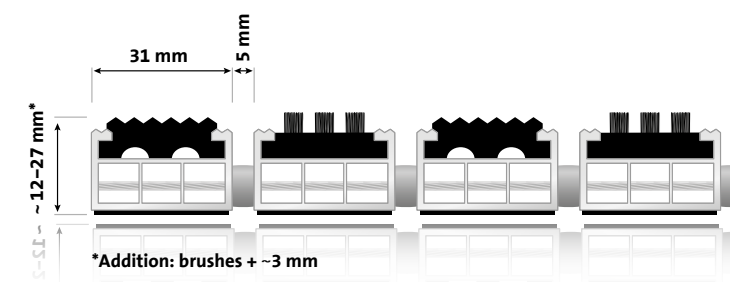





## entrada® KLASSIK »Safe« / »Minibrush«

Aluminium profile mat with rubber profile and minibrush

Effective removal of coarse dirt and water with increased non-slip safety for entrances which are frequented to a normal to heavy extent. Suitable for external areas.

### Examples of use

Entrance areas which are frequented to a normal to heavy extent, for example schools, public institutions, shopping centres etc.

<b>Aluminium profile</b>	Rollable, durable entrance mat made of torsion-resistant aluminium profile ( <b>1.5 mm wall thickness</b> ) for laying onto ground, anodization possible in different colours
<b>Upper material<sup>1</sup></b>	Anti-slip rubber profile (EPDM), fluted, UV-resistant; non-slip properties R9 acc. DIN 51130; Minibrushes: robust, durable Nylon 6.6
<b>Underside</b>	Footfall sound absorption profiles
<b>Connection</b>	Galvanised wire cable; spacers made of LD-PE with EPDM proportion
<b>Colours</b>	Rubber profile: black, grey, brown; Minibrushes: grey, black
<b>Mat height (mm)</b>	17 / 22
<b>Profile distance</b>	5 mm
<b>Type of dirt</b>	Coarse dirt; Zone 1

<sup>1</sup>optional with bfl-s1

### Price & weight (information per m<sup>2</sup>)

Height 17 mm	613,90€	~ 17,0 kg
Height 22 mm	633,90€	~ 17,5 kg

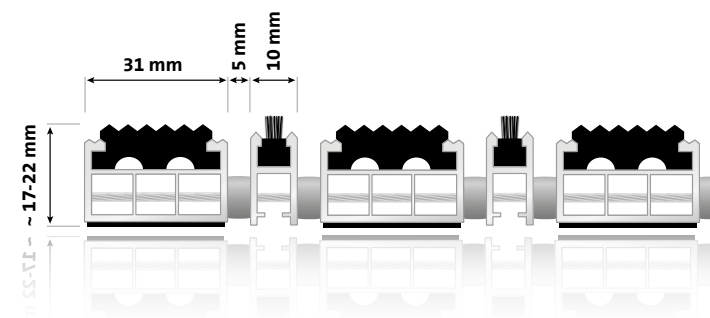

## entrada® WORK »Plus«

Aluminium profile mat with minibrush

Effective coarse dirt removal thanks to widely spaced brush profiles that penetrate deeply into the gaps in shoe treads. Suitable for external areas.

### Example applications

Entrance areas with normal to heavy foot traffic and high coarse dirt accumulation, e.g. schools, shopping centres, sports facilities etc.

<b>Aluminium profile</b>	Rollable, durable entrance mat made of torsion-resistant aluminium profile ( <b>1.5 mm wall thickness</b> ) for laying directly onto the floor
<b>Upper material<sup>1</sup></b>	Robust, durable Nylon 6.6
<b>Underside</b>	On request footfall noise absorbent levelling mat (3 mm)
<b>Connection</b>	Stainless steel cable, spacers made from LD-PE with EPDM
<b>Colours</b>	Black, grey
<b>Mat Height (mm)</b>	17 / 22
<b>Profile distance</b>	3 - 5 mm
<b>Type of dirt</b>	Coarse and fine dirt, Zones 1 and 2

<sup>1</sup>optional with bfl-s1

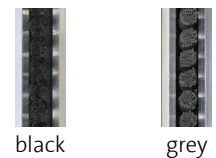

### Price & weight (information per m<sup>2</sup>)

Height 17 mm	843,90€	~ 19,5 kg
Height 22 mm	853,90€	~ 20,0 kg

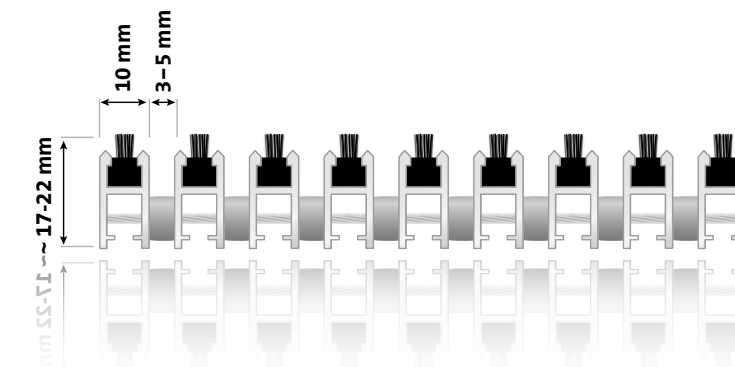



# entrada® ROBUST

## Increased wall thickness for high loads

With their reinforced walls, the aluminium profile mats entrada ROBUST are especially designed for increased loads and can be driven over in a pallet truck. They are available with different upper materials which permit use in indoor and outdoor areas.



### Examples of use

Entrance and passage areas with increased loads, e.g. airports, shopping centres, supplier entrances etc.

<b>Aluminium profile</b>	Entrance mat made of torsion-resistant aluminium profile ( <b>wall thickness up to 2.5 mm</b> ) for laying onto ground and self-supporting subconstruction to be provided by customer, maximum support width 300 mm), anodization possible in different colours
<b>Underside</b>	Footfall sound absorption profiles
<b>Connection</b>	Galvanised wire cable; spacers made of LD-PE with EPDM proportion
<b>Mat Height (mm)</b>	12 / 17 / 22 / 27 / 42
<b>Profile distance</b>	4 mm
<b>Upper material<sup>1</sup></b>	Ribbing Polypropylene, UV-resistant, R11 acc. to DIN 51130 Brush profile: robust, durable Nylon 6.6, R13 acc. to DIN 51130, Rubber profile: non-slip rubber profile (EPDM), fluted, UV-resistant; R9 acc. to DIN 51130
<b>Colours</b>	Rips: black, anthracite, grey, brown, red, sand Brush profile: black, grey, brown, red, blue, black / grey Rubber profile: black, grey, brown
<b>Type of dirt</b>	Coarse dirt Zone 1, fine dirt Zone 2, coarse and fine dirt Zone 2

<sup>1</sup>optional with bfl-s1

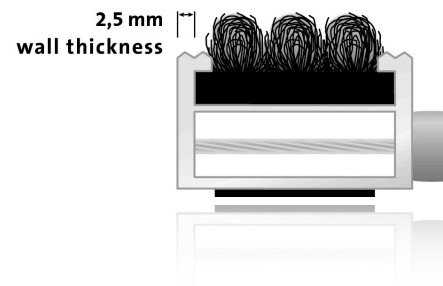

## entrada® ROBUST »Rips«

Aluminium profile mat with ribbing



### Prices & weights (information per m<sup>2</sup>)

Height 12 mm	469,90 €	~ 11,5 kg
Height 17 mm	489,90 €	~ 13,5 kg
Height 22 mm	509,90 €	~ 14,5 kg
Height 27 mm	539,90 €	~ 15,5 kg
Height 42 mm	769,90 €	~ 26,0 kg

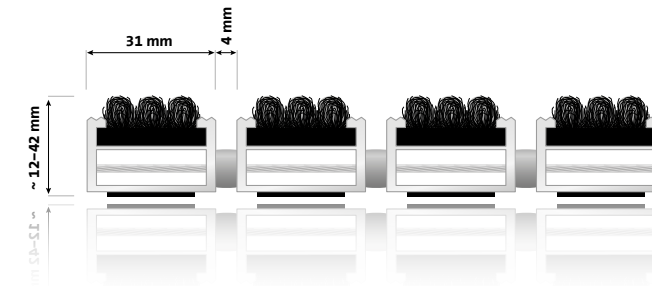

## entrada® ROBUST »Safe«

Aluminium profile mat with rubber profile



### Prices & weights (information per m<sup>2</sup>)

Height 12 mm	553,90 €	~ 15,0 kg
Height 17 mm	573,90 €	~ 16,0 kg
Height 22 mm	593,90 €	~ 17,0 kg
Height 27 mm	613,90 €	~ 18,0 kg
Height 42 mm	803,90 €	~ 32,0 kg

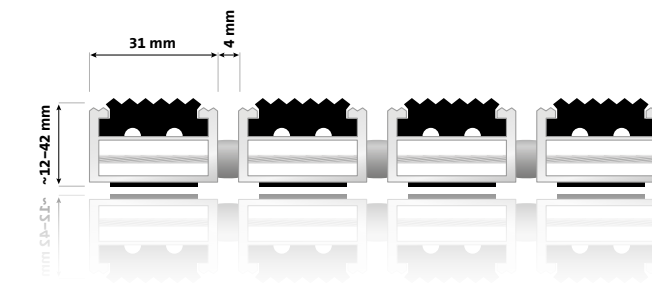

## entrada® ROBUST »Work«

Aluminium profile mat with brush profile



### Prices & weights (information per m<sup>2</sup>)

Height 12 mm	653,90 €	~ 14,0 kg
Height 17 mm	673,90 €	~ 14,5 kg
Height 22 mm	693,90 €	~ 16,5 kg
Height 27 mm	723,90 €	~ 17,5 kg
Height 42 mm	993,90 €	~ 32,0 kg

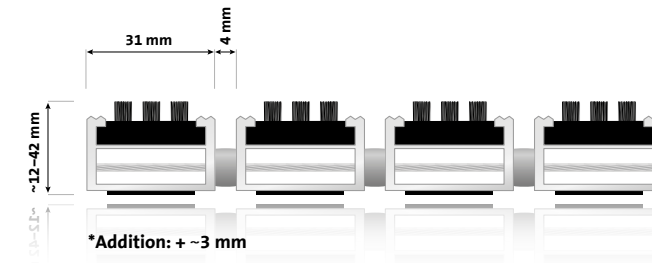

## entrada® ROBUST »Rips« / »Work«

Aluminium profile mat with ribbing and brush profile



### Prices & weights (information per m<sup>2</sup>)

Height 12 mm	569,90 €	~ 13,0 kg
Height 17 mm	589,90 €	~ 14,0 kg
Height 22 mm	609,90 €	~ 16,0 kg
Height 27 mm	639,90 €	~ 17,0 kg
Height 42 mm	889,90 €	~ 29,0 kg

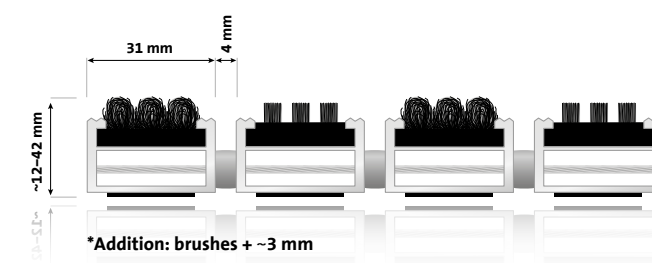



# entrada® ROYAL

## Aluminium profile mat with ribbing

High fine dirt and humidity removal through wide ribbing for indoor and roofed entrance areas which are frequented to a normal to heavy extent.

### Examples of use

Entrance areas which are frequented to a normal to heavy extent, e.g. boutiques, banks, office buildings etc.

<b>Aluminium profile</b>	Rollable, durable entrance mat made of torsion-resistant aluminium profile ( <b>1.5 mm wall thickness</b> ) for laying onto the ground, anodizing possible in different colours
<b>Underside</b>	Footfall sound absorption profiles
<b>Connection</b>	Galvanised wire cable; spacers made of LD-PE with EPDM proportion
<b>Mat Height (mm)</b>	17 / 22
<b>Profile distance</b>	5 mm
<b>Upper material<sup>1</sup></b>	Rips: Polypropylene, UV-resistant, R11 acc. to DIN 51130 Brush profile: robust, durable Nylon 6.6, R13 acc. to DIN 51130, Rubber profile: non-slip rubber profile (EPDM), fluted, UV-resistant; R9 acc. to DIN 51130
<b>Colours</b>	Rips: black, anthracite, grey, brown, red, sand Brush profile: black, grey, black / grey, more colours available Rubber profile: black, grey, brown
<b>Type of dirt</b>	Coarse dirt Zone 1, fine dirt Zone 2, coarse and fine dirt Zone

<sup>1</sup>optional with bfl-s1

## entrada® ROYAL »Rips«

Aluminium profile mat with ribbing



### Prices & weights (information per m<sup>2</sup>)

Height 17 mm	399,90€	~ 11,5 kg
Height 22 mm	409,90€	~ 12,5 kg

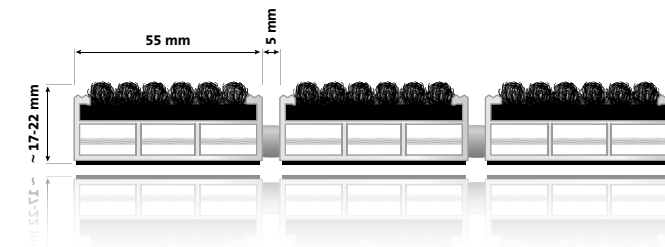

## entrada® ROYAL »Safe«

Aluminium profile mat with rubber profile



### Prices & weights (information per m<sup>2</sup>)

Height 17 mm	489,90€	~ 16,0 kg
Height 22 mm	499,90€	~ 16,5 kg

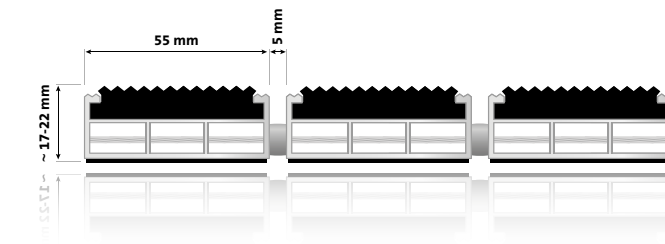

## entrada® ROYAL »Work«

Aluminium profile mat with brush profile



### Prices & weights (information per m<sup>2</sup>)

Height 17 mm	703,90€	~ 15,0 kg
Height 22 mm	713,90€	~ 15,5 kg

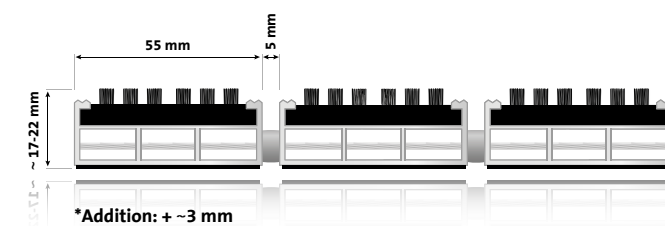

## entrada® ROYAL »Rips« / »Work«

Aluminium profile mat with ribbing and brush profile



### Prices & weights (information per m<sup>2</sup>)

Height 17 mm	563,90€	~ 12,5 kg
Height 22 mm	573,90€	~ 13,0 kg

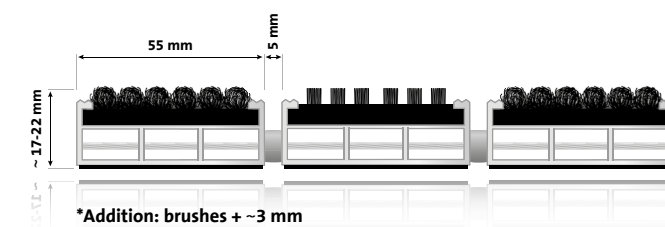



# entrada® ROYAL PLUS

## Aluminium profile mat with extra-wide profile

High level of fine dirt and humidity removal through wide ribbing for indoor and covered entrance areas with strong to extreme levels of foot traffic.



### Examples of use

Entrance areas which are frequented to a normal to heavy extent, e.g. boutiques, banks, office buildings etc.

<b>Aluminium profile</b>	Rollable, durable entrance mat made of torsion-resistant aluminium profile ( <b>3 mm wall thickness</b> ) for laying onto the ground, anodizing possible in different colours
<b>Underside</b>	Footfall sound absorption profiles
<b>Connection</b>	Galvanised wire cable; spacers made of LD-PE with EPDM proportion
<b>Mat Height (mm)</b>	22
<b>Profile distance</b>	5 mm
<b>Upper material<sup>1</sup></b>	Rips: Polypropylene, UV-resistant, R11 acc. to DIN 51130 Brush profile: robust, durable Nylon 6.6, R13 acc. to DIN 51130, Rubber profile: non-slip rubber profile (EPDM), fluted, UV-resistant; R9 acc. to DIN 51130
<b>Colours</b>	Rips: black, anthracite, grey, brown, red, sand Brush profile: black, grey, black / grey, more colours available Rubber profile: black, grey, brown
<b>Type of dirt</b>	Coarse dirt Zone 1, fine dirt Zone 2, coarse and fine dirt Zone 2

<sup>1</sup>optional with bfl-s1

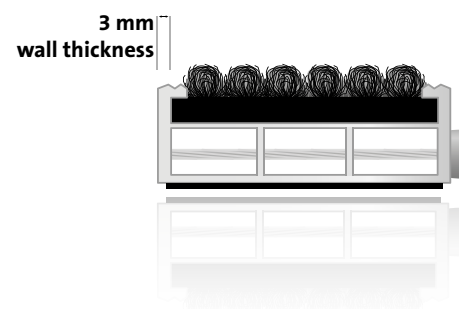

## entrada® ROYAL PLUS »Rips«

Aluminium profile mat with ribbing



### Prices & weights (information per m<sup>2</sup>)

Height 22 mm    579,90€    ~ 13,5 kg

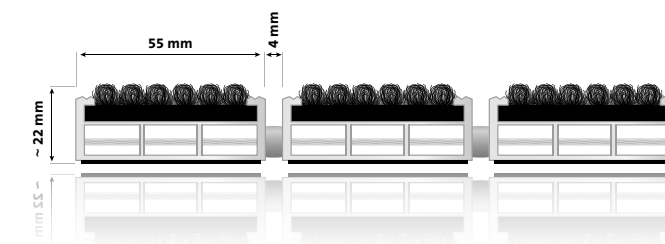

## entrada® ROYAL PLUS »Safe«

Aluminium profile mat with rubber profile



### Prices & weights (information per m<sup>2</sup>)

Height 22 mm    679,90€    ~ 20,5 kg

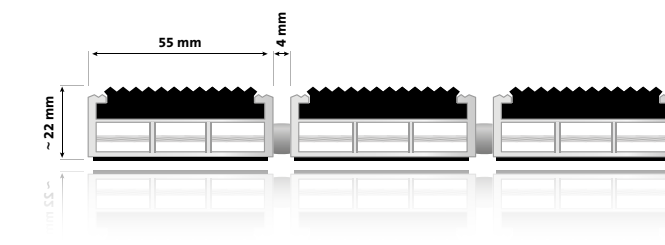

## entrada® ROYAL PLUS »Work«

Aluminium profile mat with brush profile



### Prices & weights (information per m<sup>2</sup>)

Height 22 mm    829,90€    ~ 19,0 kg

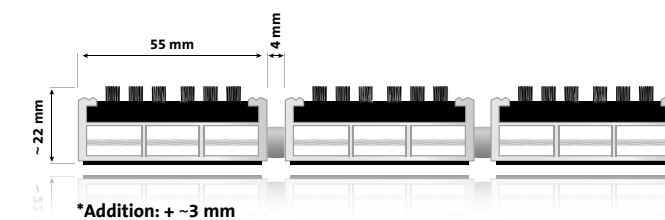

## entrada® ROYAL PLUS »Rips« / »Work«

Aluminium profile mat with ribbing and brush profile



### Prices & weights (information per m<sup>2</sup>)

Height 22 mm    709,90€    ~ 18,5 kg

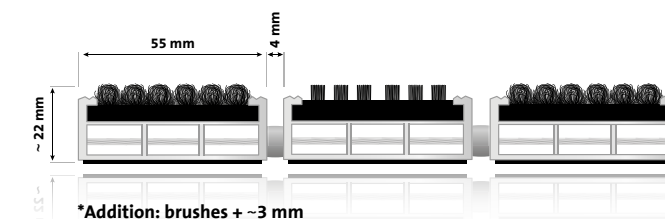



## Entrance mat with logo

Aluminium profile mat with custom logo

Individuality is an important factor for many customers, allowing a personal touch in entrance areas. Effective collection of fine dirt particles and water ensured.

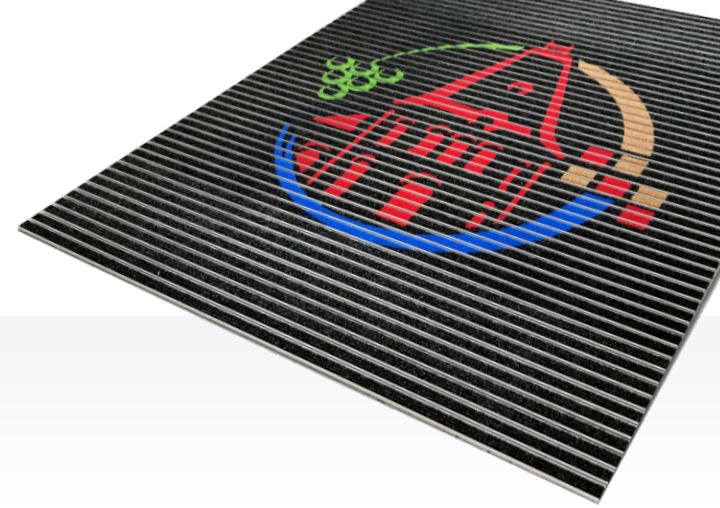

## Tactile guidance system

For all aluminium profile mats

The tactile guidance system is a complete system for additional safety. It comprises mat components for blind people and those with a visual impairment.

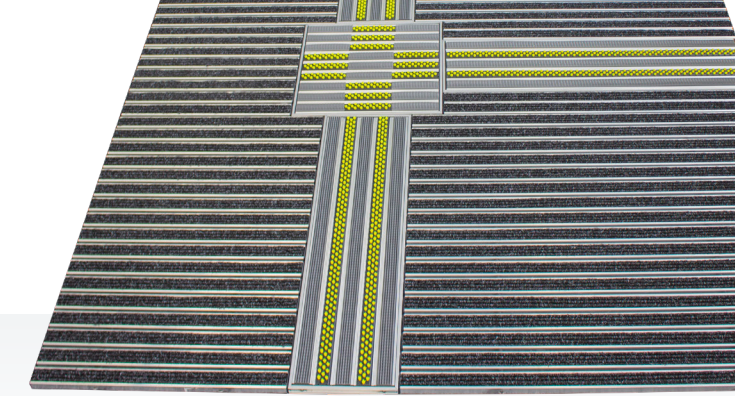

### Applications

- all entrance areas indoors and in outside roofed-over spaces

### Safety and function

- safety and function: Mat can be used flexibly in accordance with choice of CLASSIC, ROBUST, or ROYAL

### Colours and sizes

- a flexible and diverse choice of colours and sizes

### Price

- on request

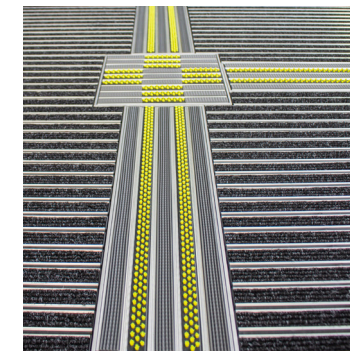
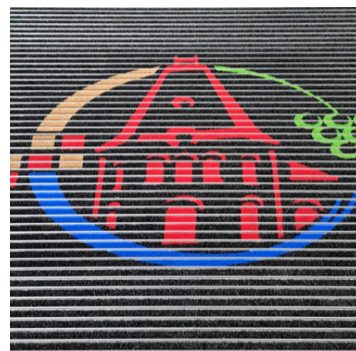

### Applications

- e.g public buildings, schools, hospitals

### Safety and function

- the height difference between the brushes and the rubber profiles and their perpendicularity to the rest of the mat can be felt by blind people and those with a visual impairment

### Colours and sizes

- height and size can be planned individually as a continuation of embedded lines or joints in the floor. The system is suitable for mat heights of 12 mm to 42 mm. The number of strips of brushes/ rubber inserts can be chosen freely as desired

### Material

- in accordance with the choice of different profile/ covering components

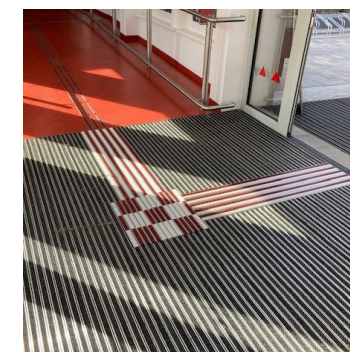
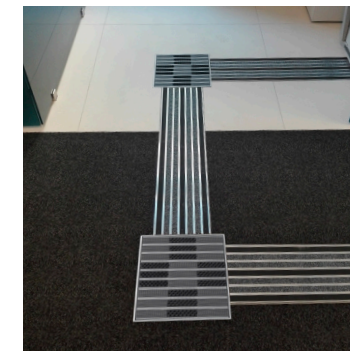



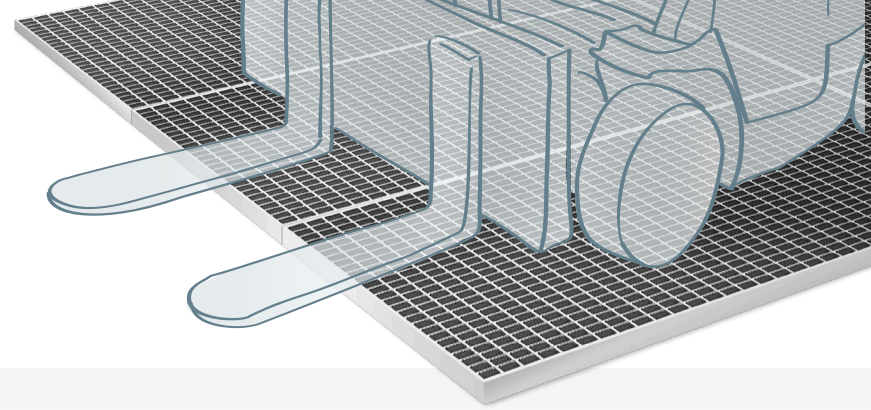

## entrada T-REX mat module

Effective tyre cleaning and dirt-trapping mat for industrial halls and heavy load areas

The T-REX mat module has been especially designed for use in entrance areas and delivery zones with heavy traffic, and efficiently cleans vehicle tyre profiles.

The combination of galvanised steel grating and extremely robust strip brushes makes the T-REX mat module ideal for use in production facilities, trade fair halls and agriculture.

The cleaning system can be driven on by cars, trucks and forklifts, protecting the floor from dirt at all times. The modules can be equipped with ramps so that they do not need to be set into the floor..



Can be driven over a ramp when laid on top.

### Applications

- industrial halls and warehouses with heavy traffic from the outside into the building
- enterprises with heavy traffic from the warehouse into clean production areas
- trade fair halls

### Safety and function

- reduction in cleaning costs through cleaning of tyre profiles
- increase in work safety
- improvement in cleanliness within the enterprise
- protection of industrial floors
- reduction in risk of germs being spread between different production areas by transport vehicles
- long lifetime

### Material

- hot-dip galvanised, press-welded gratings
- PVC / PA 6.6 brush strips
- Optional: stainless steel tub and approach ramps



## KLASSIK "Drive" forklift mat

Lasting dirt trapping for warehouse and shipping areas

This forklift mat effectively removes dirt and moisture from the wheels of your warehouse vehicles, keeping your halls dry and clean. It was developed especially for use with the tyres of warehouse vehicles and is ideal for intensive usage around loading ramps and entrance gates.

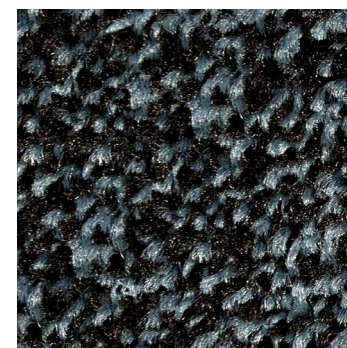
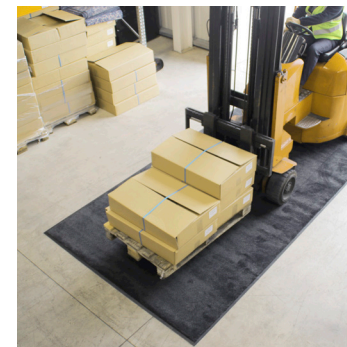

### Applications

- e.g. industry, commerce, trade, warehouse and shipping logistics

### Safety and function

- reduced risk of slipping thanks to extremely high absorbency
- extremely good cleaning effect for the tyres of transport vehicles
- high adherence to floor due to extra-thick mat backings made from nitrile rubber

### Sizes

- standard widths: 85, 115, 150, 200 cm
- lengths of up to 7 m possible
- mats made to measure and custom shapes available on request

### Material

- top material: Micro nylon and HTN polyamide 6 (50% recycled yarn)
- backing material: 100% nitrile rubber



## Accessories and Service



### Angular frame

Accurate and sturdy for installation into ground recesses

We offer custom-made aluminium or stainless steel angular frames for installation in floor recesses. Please provide us with your outer frame dimensions to enable us to produce the aluminium profile mats according to your precise requirements.

#### Designs & prices (price per running metre)

##### »Smart« Angular

For mat height	Height / width / thickness	Price
10 / 12 mm	13,5 / 30 / 4,6 mm	14,90 €

##### Aluminium Angular

For mat height	Height / width / thickness	Price
12 mm	15 / 24 / 3 mm	15,90 €
17 mm	22 / 24 / 3 mm	16,90 €
22 mm	26 / 24 / 3 mm	17,90 €
27 mm	30 / 24 / 3 mm	18,90 €
42 mm	45 / 30 / 3 mm	42,90 €

##### Steel Angular

For mat height	Height / width / thickness	Price
17 mm	20 / 25 / 3 mm	on request
22 mm	25 / 20 / 3 mm	on request
27 mm	30 / 25 / 3 mm	on request

#### Custom shapes

Cut-outs, curves and chamfers can be produced according to sketch or template subject to an additional charge (see Page 42). See page 41 for general installation information.



Angular frame »Smart«



Aluminium angular frame with floorbolts



Steel angular frame with floor bolts



### entrada trap system type »22«

Compact dirt-trapping mat

The aluminium trap system type »22« is a high-quality dirt-trapping substructure solution for your entrance area. It is suitable for all entrada 22 aluminium profile mats. The system can be installed both inside and outside buildings. The trap system can be produced in virtually any dimensions.

Stainless steel option now available! Prices on request

Larger areas can be created using several dirt-trapping trays. Square tubes are inserted in running direction at a distance of approx. 30 cm (30 x 30 x 3 mm) for the perfect support.

On request, a cut-out can be made for the water drain

#### Examples of use

Public buildings, offices, hotels, railways stations, markets, shopping centres etc.

<b>Material</b>	Aluminium Stainless steel (prices on request)
<b>Use</b>	All entrada 22 aluminium profile mats
<b>Floor drain</b>	Free production to customer specification (diameter 9.5 cm)
<b>Height</b>	80 mm
<b>Dimensions</b>	Production to customer specification; all sizes possible thanks to modular construction. For widths of over 2800 mm or walking depth of 1300 mm or more, the tray is supplied in sections. Custom shapes available upon request.

#### Price & weight (information per m<sup>2</sup>)

Height 80 mm	469,90 €	~ 12,5 kg
--------------	----------	-----------

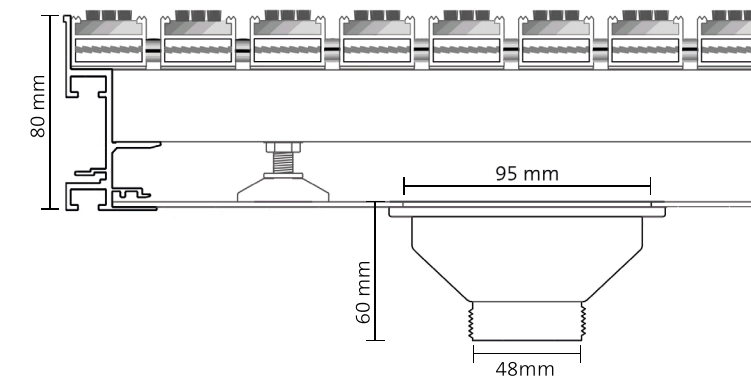
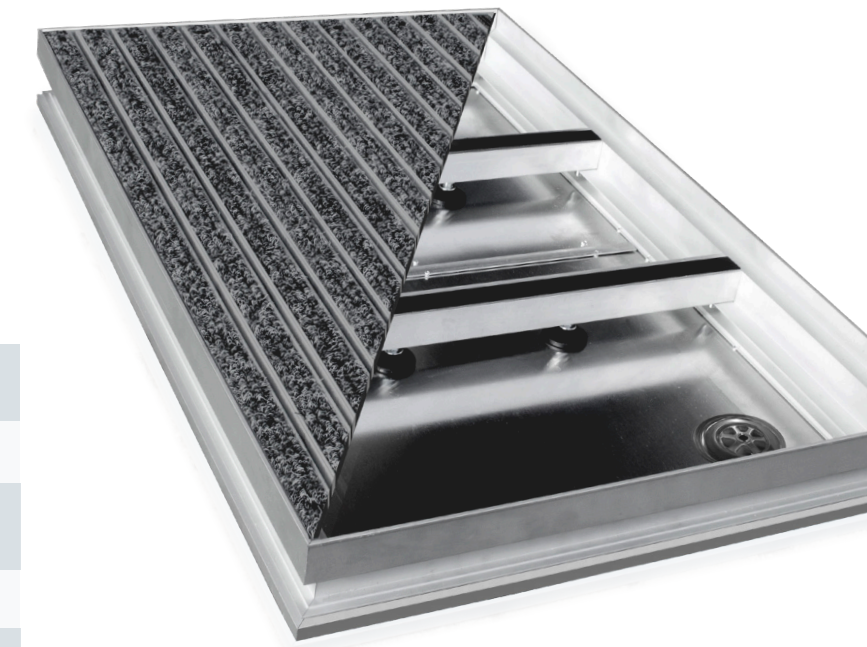



## Ramp profile

For use without floor recess

The ramp profile permits the use of aluminium profile mats even without a floor recess. It can enclose the aluminium profile mat completely around all four sides or only be mounted on one to three sides of the aluminium profile mat.

A circumferential ramp profile is supplied in four parts and can be sturdily mounted and ready for operation within a very short time thanks to the screw connections.

<b>Material</b>	Aluminium
<b>Colours</b>	silver, black
<b>Joint</b>	Screw joints
<b>For mat heights</b>	12 mm / 17 mm / 22 mm



### Designs & prices (information per m<sup>2</sup>)

For Mat Height	Height	Width	Price
12 mm	12 mm	45 mm	38,90 €
17 mm	17 mm	58 mm	39,90 €
22 mm	19 mm	50 mm	42,90 €

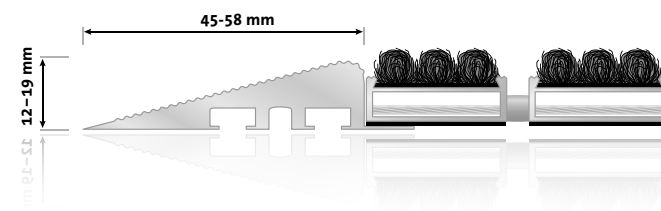

## Stainless steel profile

Individualism for your entrance mat system

Give your entrance area that extra touch. Supplement your aluminium profile mat with a stainless steel profile to which you can also add custom lettering.

The high-quality, laser-cut stainless steel profile is permanently joined to the aluminium profile mat and is available in heights of 12 mm, 17 mm and 22 mm.



## Anodization

By anodizing the aluminium profile mats and the angular frame, the entrance mat systems can be harmonised in terms of colour with their environment and the surrounding floor covering. You can select any colour of your choice.



## entrada covering rail »Curve«

End rail for entrance mats in rotating doors

The »Curve« covering rail is used to protect and cover mitre or bevel cuts for custom-shaped entrance mats. The rail not only covers the sharp edges but also lends aluminium profiles in rotating doors an elegant finish.

### Available options (per running metre)

<b>Material</b>	Stainless steel
<b>For mat heights</b>	12 mm / 17 mm / 22 mm
<b>Material thickness</b>	1 mm
<b>Max. length</b>	3 m

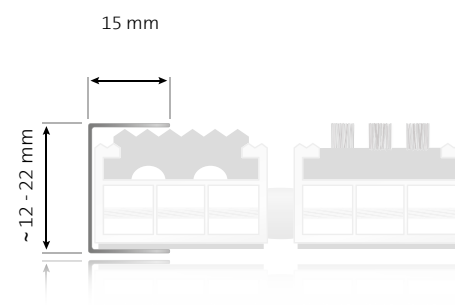

## Levelling mat »Balance«

The »Balance« levelling mat is used for levelling out differences in height when laying carpet matting and aluminium profiles in floor recesses. This makes it possible to lay a transition without the need for a threshold.

### Available options

<b>Heights</b>	3 mm / 6 mm / 14 mm
----------------	---------------------

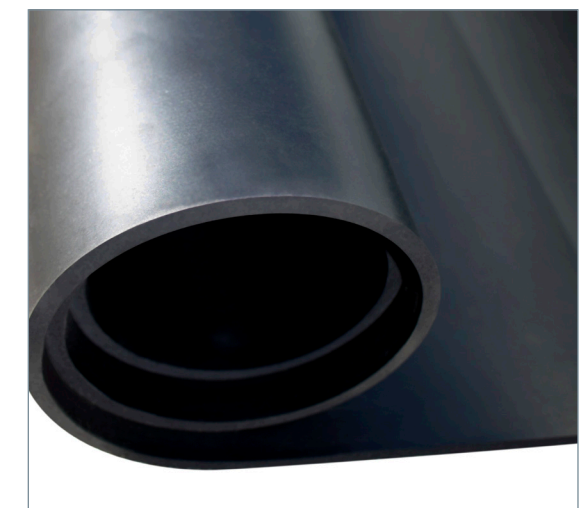



## Ribbed Raw Hair Mat »Easy«

Effective dirt trap for floor recesses

The ribbed raw hair mat »Easy« is a low-price alternative to aluminium profile mats for indoor and covered outdoor areas. Its robust needle fleece surface features good absorption of dirt and moisture and provides a firm grip. The product can be easily cut and laid in existing recesses.

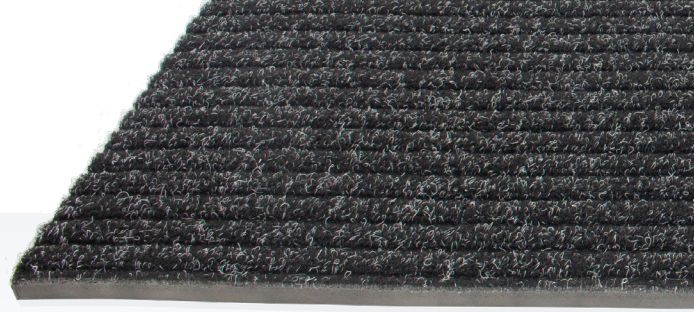

## Coconut mats

A natural dirt-trap in a choice of colours

Like many other natural materials, coconut mats have their own special flair. It is for this reason that they are still often used in mats for trapping fine dirt and humidity. By absorbing and emitting moisture, coconut fibres create a balanced room climate, as well as being antistatic with good noise and heat insulation properties.



### Applications

- indoor and covered outdoor areas
- suitable for wheelchairs and prams
- detached houses, company entrances

### Load capacity

- up to 400 treads per day

### Colours and sizes

- colours: anthracite, light grey
- for floor recesses between 10 - 23 mm
- standard width: up to 2 m, reeled material
- weight: 5.0 kg per m<sup>2</sup>
- webs can be laid seamlessly

### Material

- needle fleece with ribbed structure
- upper material: 100 % polypropylene, non-deteriorating PP fibre
- back coating NSF foam

### Designs

Height	Colour
12 mm	anthracite, light grey
17 mm	anthracite, light grey
20 mm	anthracite, light grey
23 mm	anthracite, light grey

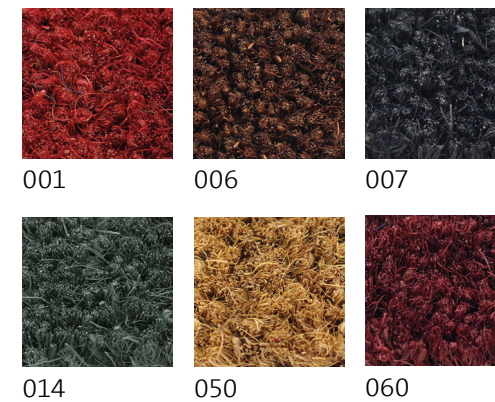

### Applications

- retail, stores, craft trades, industry

### Safety and function

- reduced risk of slipping thanks to high moisture absorption
- can be cut to size for use in existing recesses
- for flat installation in our aluminium mat ramp
- also available upon request in natural colour with Cfl-s1

### Colours and sizes

- colours: red, brown, black, grey, natural, bordeaux
- heights, natural coconut: 17 mm, 20 mm, 24 mm, 30 mm
- height, coconut coloured: 17 mm
- length: up to 12 m

### Available options

Height	Colour
17 mm	natural
17 mm	red, brown, black, grey, bordeaux
20 mm	natural
24 mm	natural
30 mm	natural







## Dirt-trapping mat »Klassik«

Effective dirt-trapping mat for your entrance area

The dirt-trapping mat »Klassik« stands out thanks to its excellent cleaning functionality and high durability. The 100% solution-dyed polyamide-nylon fibres are available in 9 colour mixes and absorb large quantities of dirt and moisture.

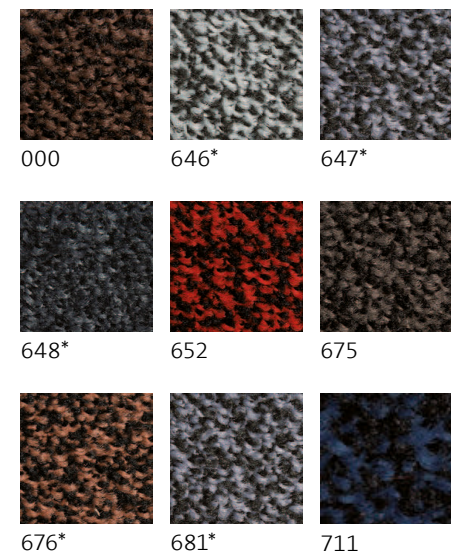

000 646\* 647\*

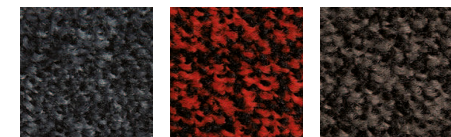

648\* 652 675

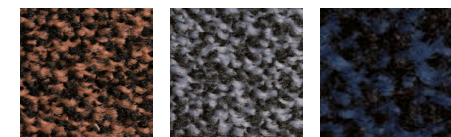

676\* 681\* 711

\* only these colours available from a width of 151 cm



Printed mats available at [www.entrada-matten.de](http://www.entrada-matten.de)

### Applications

- e.g. industry, retail, trade, official public buildings, hospitals and kindergartens

### Safety and function

- lower risk of tripping due to extra-wide safety edging
- reduced risk of slipping thanks to high moisture absorption
- high floor adhesion with mat backing made of heavy nitrile rubber
- low flammability Cfl -s1 acc. to EN 13501-1

### Colours and sizes

- standard widths: 85, 115, 150, 200 cm
- all widths available as special sizes up to 240 cm
- lengths of up to 10 m possible
- mats made to measure and custom shapes available on request
- reinforced stepping edge possible, for instance, to facilitate use by wheelchairs

### Material

- upper material: 100% high-twist nylon
- backing material: 100% nitrile rubber
- suitable for industrial cleaning up to 60 °C (also suitable for tumble-drying)



## Anti-dirt mat »Maximus®«

Representative dirt-trapping mat for recesses and long hallways

The anti-dirt mat »Maximus®« radiates comfort through its high-quality tufting velour. Specially-arranged hollow fibres ensure a good cleaning effect. The high-quality appearance is achieved through strong colours and attractive mottling.



80.01 80.02 80.03



80.04 80.07 81.01

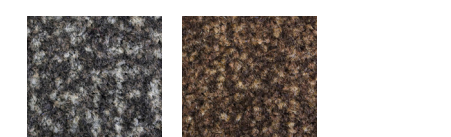

81.02 81.04

The anti-dirt carpets are the optimum supplement for your anti-dirt zones in the entrance area:

- antistatic properties
- easy to install: simply cut and fix
- the carpets can be cut easily and laid in various recesses - also next to each other

### Material

- upper material: High-quality tufting velour
- backing material coating: heavy coating made of Vinyl
- low flammability: Bfl -s1 acc. EN 13501-1
- non-slip properties: DS acc. DIN EN 13893

### Size

- height: approx. 10 mm
- standard widths: 130 cm and 200 cm wide rolled goods (incl. border)
- webs can be laid seamlessly
- on request, also available with a 2.5 cm safety step edge at the start and end of the mat
- mats available cut to size and in special shapes





## Rubber Mat »Bee 22«

Effective non-slip properties with high levels of moisture

Rubber mats are non-slip, impact-absorbent and water-permeable. They are therefore particularly suitable for areas with frequent moisture and snow. The rubber ring mat »Bee 22« is highly effective in dissipating fluids thanks to its napped underside.

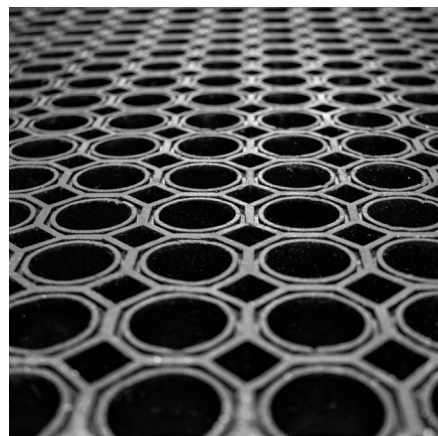
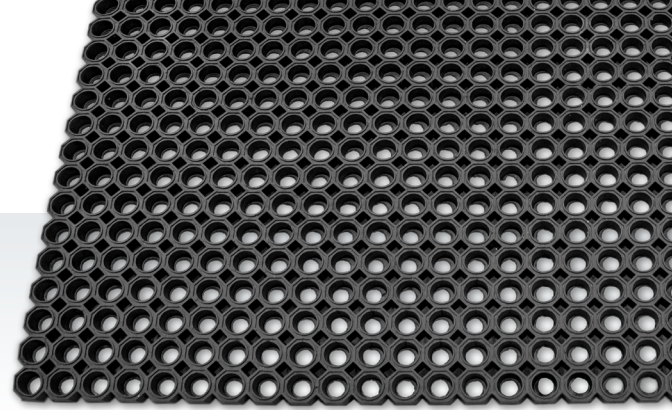

### Applications

- Entrance mat for use in areas with high levels of moisture
- Workplace mat for use by machines, work benches and assembly places.
- Protection against sludge on sandy paths and walkways
- Washing halls (washing bays)

### Safety and function

- The mat's high permeability to moisture and snow reduces the danger of slipping
- Good floor adhesion thanks to the mat's inherent weight

### Colours and sizes

- Colour: black
- Weight: approx. 12.5 kg / m<sup>2</sup>



### Available options

Height	Width/depth
22 mm	Panel 150 × 100 cm
22 mm	Individual custom dimensions

## Correct planning for frames and mats

### Angular frames

Our aluminium profile mats should be installed in an angular frame for optimum fit. When using aluminium profile mats and angular frames in the outside area, a drain must be available in order to secure the water drainage.

The frame must close flush with the floor covering or the screed / smoothing (see Fig.) An absolutely flat subsurface is the prerequisite so that the mat lies evenly on the surface. Please observe the clearance height for laying of the entrance mat.

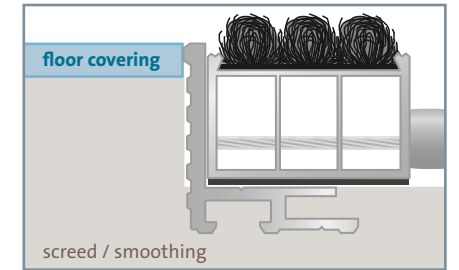

Installation: The angular frame must close flush with the floor covering and the smoothing/screed.

### Division of large aluminium profile mats

Particularly large mats will be divided in order to guarantee clean installation and easy care. Divisions take place from approx. 2500 mm rod length or from a weight of approx. 45 kg.

We therefore recommend a division in the rod length (from approx. 2500 mm) or in walking direction (from approx. 45 kg weight). A division in the rod length should not take place directly in the walking zone, otherwise there is a risk of tripping.

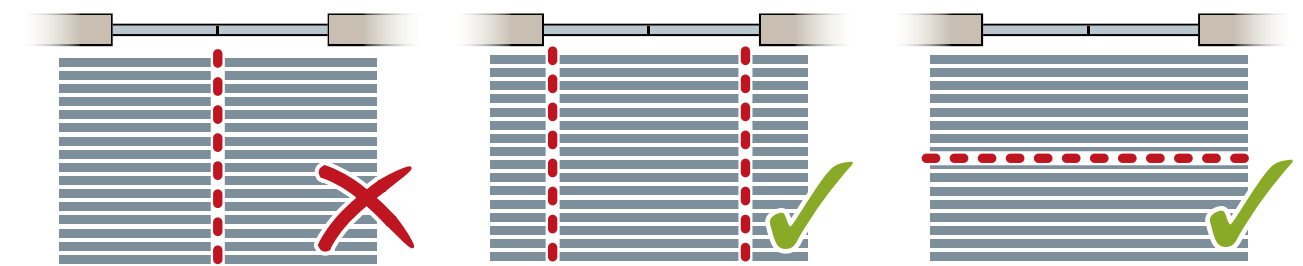

Never divide in the direct walking zone: Risk of tripping.

Correct division in case of rod lengths over 2500 mm or over 45 kg weight.

### Care guidelines

In order to achieve a long lifetime for our aluminium profile mats, a flat subsurface is essential. Unevennesses through poorly-executed smoothing/screeds or little stones under the aluminium profiles may lead to premature material fatigue. You can achieve the maximum lifetime through professional installation and regular cleaning of the ground recess.



# Order

## Measurement information

Please remember to state the rod length and walking direction dimensions. Depending on the measurement information, we calculate the right mat finished dimensions for you:

- a) On ordering **incl. angular frames** please state the frame outside dimensions.
- b) On ordering **for existing angular frames** please state the frame inside dimensions.
- c) Alternatively, you can also state the **mat finished dimensions** directly.

## Templates for special mat shapes

We are happy to send you tips and tricks for the preparation of templates, or you can look on our website in the »Service« area. Alternatively, we will take over the preparation of the templates and take measurements on-site.

## Special productions

Aluminium profile mats and angular frames can also be produced in special shapes. Please enclose a sketch, stating the exact dimensions, with your order or send us a special template. Please mark the walking direction and, in the case of a template, the top side.

### Price determination

The original size of the mat prior to cutting is always calculated, plus the cutting costs. Please observe that, in the case of certain special shapes (e.g. rectangular cut-out with chamfer), several cuts will be necessary. We can of course prepare you a detailed offer with drawing. We are also happy to offer you our measurement and laying service.

	Cut-outs	Chamfers	Curves
<b>Mats</b>	59,90 € / piece	89,90 € / rm	89,90 € / rm
<b>Frames</b>	21,90 € / piece	19,90 € / piece	42,90 € / rm
<b>Bins</b>	Price on request	Price on request	Price on request

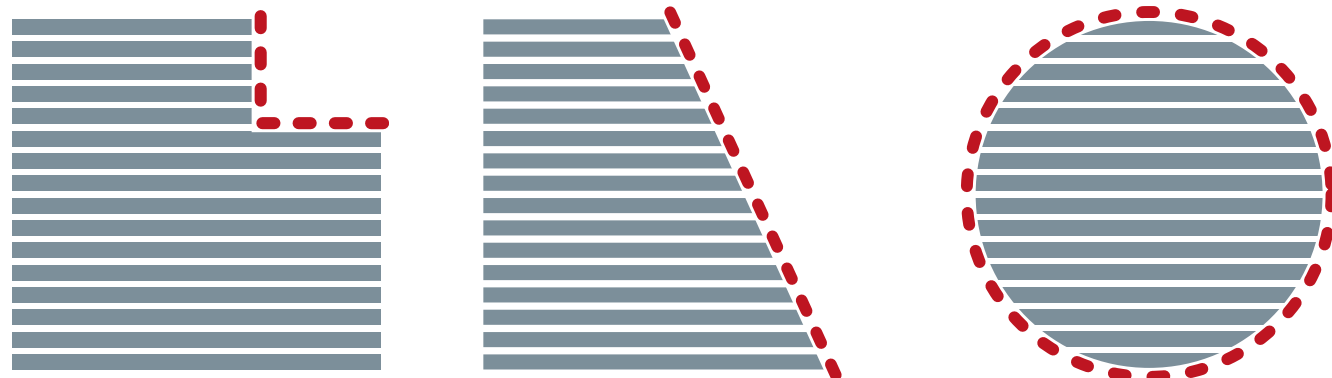

# Fax form

Request  Order

Send by e-mail to: [info@entrada-matten.de](mailto:info@entrada-matten.de)  
Or by fax to: +49 (0)531 886 871 - 11

<b>Construction project</b>		_____	
<b>Product designation</b>		_____	
<b>Quantity</b>	_____ piece		
<b>Profile height</b>	<input type="checkbox"/> 10 mm	<input type="checkbox"/> 17 mm	<input type="checkbox"/> 27 mm
	<input type="checkbox"/> 12 mm	<input type="checkbox"/> 22 mm	
<b>Colour/ design</b>		_____	
<b>Aluminium rod length</b>	_____ mm	<b>Depth/walking direction</b>	_____ mm
<b>These dimensions areas follows</b>	<input type="checkbox"/> Frame outside dimensions	<input type="checkbox"/> Frame inside dimensions	<input type="checkbox"/> Mat finished dimensions
	<input type="checkbox"/> Special production acc drawing (enclosed/ on free area)	<input type="checkbox"/> Special production acc. template (will be sent separately)	
<b>Accessories</b>			
<b>Frame required:</b>	<input type="checkbox"/> Yes	<input type="checkbox"/> No	
<b>Frame material</b>	<input type="checkbox"/> Aluminium	<input type="checkbox"/> Steel	

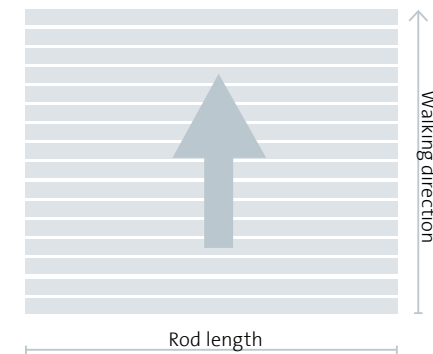

The aluminium profile mats are if possible produced in one piece. If the rod length exceeds 2500 mm or the weight 45 kg, the mats are divided. Prior to delivery, you will receive an assembly sketch from us with our suggested division.

### Invoice address

Company \_\_\_\_\_

Name \_\_\_\_\_

Street \_\_\_\_\_

Postcode \_\_\_\_\_ Place \_\_\_\_\_

**Phone (mobile)** \_\_\_\_\_

E-Mail \_\_\_\_\_

Contact \_\_\_\_\_

Delivery requested by \_\_\_\_\_

### Delivery address (if deviating)

Company \_\_\_\_\_

Name \_\_\_\_\_

Street \_\_\_\_\_

Postcode \_\_\_\_\_ Place \_\_\_\_\_

Phone \_\_\_\_\_ Fax \_\_\_\_\_

E-Mail \_\_\_\_\_

Date, signature \_\_\_\_\_



# Wir freuen uns auf Ihren Anruf!

Fachberatung vom Spezialisten für Sauberlaufprodukte



#### **entrada Fußmatten GmbH**

Hinter dem Turme 5

38114 Braunschweig

Phone +49 (0)531 - 886 871 - 0

Fax +49 (0)531 - 886 871 - 11

E-Mail [info@entrada-matten.de](mailto:info@entrada-matten.de)

[www.entrada-matten.de](http://www.entrada-matten.de)

#### **Sales Office South / West**

Friedrichstraße 5

75015 Bretten

Phone +49 (0) 96 99 9 0

Fax +49 (0)7252 96 99 209

E-mail [info@entrada-matten.de](mailto:info@entrada-matten.de)